



# CAM-1000

## Angle Mount Backup Camera



Your new CAM-1000 includes:



Camera Assembly (x1)



PWR In / Video Output Cable (x1)



Hex Tool (x1)

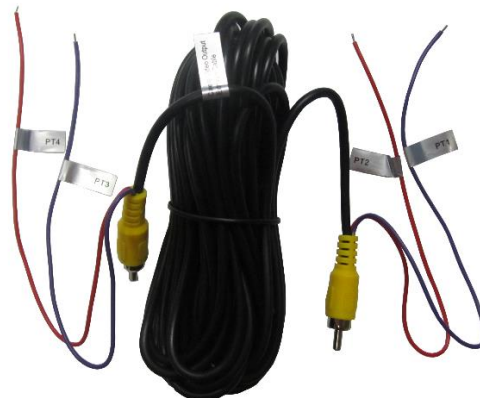

Video Extension Cable (x1)

# Table of Contents

Introduction.....	2
Basic Wiring Block Diagram.....	3
GRAFIX Trigger Setup.....	3
Wiring Connections .....	4
Camera Mounting .....	5
Position and Cable routing.....	5
Initial Alignment.....	5
Final Adjustments .....	6
Troubleshooting guide .....	6
Specifications .....	6
SERVICE AND REPAIR .....	7

## Introduction

The GRAFIX series Instrument Clusters from Dakota Digital come standard from the factory with an external SD (standard definition) video input port. This port allows the user to source video from a backup camera (such as the CAM-1000), and display that video directly on the Instrument Cluster’s display. Until the GRAFIX, this feature could only be found on newer mass-produced production vehicles, vehicles with aftermarket infotainment systems, or vehicles with LCD monitors mounted on the dash or in the rearview mirror.

Setup of the GRAFIX system to use the CAM-1000 is simple and straightforward, and as seen in the diagram(s) below the wiring is as well - which you have come to expect from Dakota Digital. Using this guide, you will be able to select the wiring method that best suits your application. Backup triggering to the GRAFIX Instrument Cluster is handled by a single wire to a control box terminal pin, of which there are several configurable pins to choose from. The video itself is a single coaxial cable (provided), that also includes a pair of built in generic control or power wires – to ease the installation process, and maintain a clean professional look.

# Basic Wiring Block Diagram

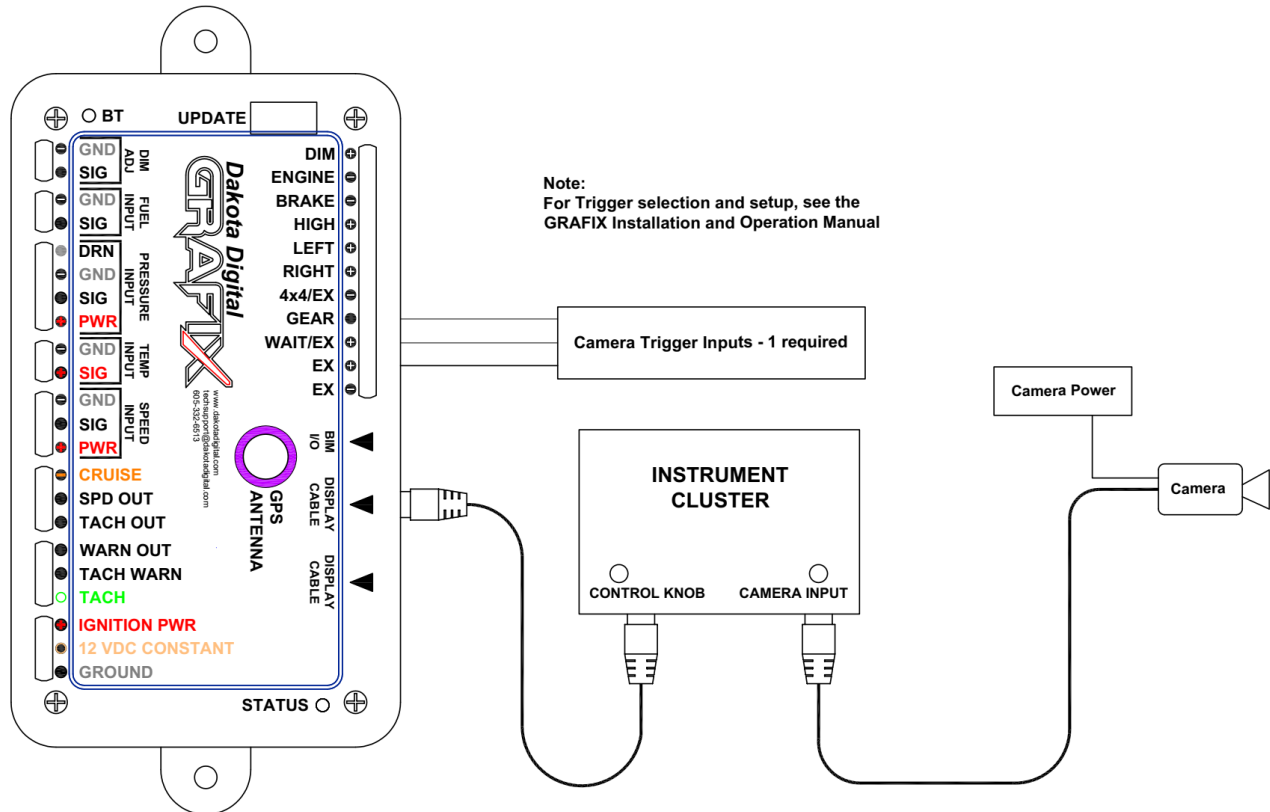

Before getting started with the installation of the CAM-1000 in the vehicle, the user must select a mounting location and understand the wiring requirements. Questions to ask could include:

- Where and how will the camera be mounted?
- Where will the power for the camera be sourced?
- What is the source for the trigger signal to the GRAFIX Control Box?
- Are backup assist lines desired? (the assist lines are on by default)
- What is the best path to route wires and get the trigger and video signal to the GRAFIX Control Box and Instrument Cluster?

## GRAFIX Trigger Setup

The GRAFIX system is designed so that the implementation of the camera input feature is simple and straightforward.

- Start with the engine off and the vehicle in park or neutral (if neutral, be sure the wheels are appropriately blocked/secured)
- Turn the key to the accessory or on position
- Tap Control Knob on the Instrument Cluster to bring up the MAIN MENU
  - If there are popup warning boxes in the menu box area, or messages in the Message Areas at this time, multiple taps may be required to get to the MAIN MENU
  - Any warnings encountered (sensor failures, required calibration, etc.), will need to be cleared before the user can proceed through to the SETUP section below.
- Rotate the Control Knob CW until **SETUP** is highlighted, tap the Control Knob to select
- A menu list: BLUETOOTH, CLOCK, SPEED, TACH, VOLT, WATER, OIL, FUEL, BIM, WARN, GFORCE, CAMERA, DEMO MODE, FULL RESET, and BACK will be displayed
- Rotate the Control Knob to **CAMERA**, tap the knob to select
  - A sub-menu list will appear in the menu box: TRIGGER and BACK
  - Rotate the knob to highlight the desired item, tap to select

- TRIGGER: GEAR-REVERSE, EX+, WAIT, DISABLE, and BACK. Rotate the knob to the desired item, tap to select
  - **GEAR-REVERSE:** If the vehicle is configured with a Dakota Digital GSS gear position sensor module (optional), the output of the GSS can be used to trigger the GRAFIX to switch to the camera input when the reverse position is detected. Connect the 1-WIRE output terminal of the GSS to the 'GEAR' terminal on the control box.
  - **EX+:** Use this menu selection when connecting the EX+ terminal of the Control Box to the vehicle's backup lights or reverse switch. If using a Dakota Digital GSS gear position sensor, the GSS BACKUP terminal can be connected to the EX+ terminal of the GRAFIX control box.
  - **WAIT:** Use this menu selection when connecting the WAIT terminal of the Control Box to the vehicle's backup lights or reverse switch. If using a Dakota Digital GSS gear position sensor, the GSS BACKUP terminal can be connected to the WAIT terminal of the GRAFIX control box.
  - **DISABLE:** Selecting DISABLE will not switch the GRAFIX display to the external camera input, regardless of the wiring or GSS gear position detected. (select this option if a camera is not connected to the system)
  - **BACK:** Will exit the TRIGGER sub-menu
- BACK: Exit the CAMERA setup

## Wiring Connections

At this time select the appropriate backup camera wiring method for the vehicle. Basic wiring methods will be discussed here, but your specific application may require deviations and your own creativity.

Refer to the diagram below:

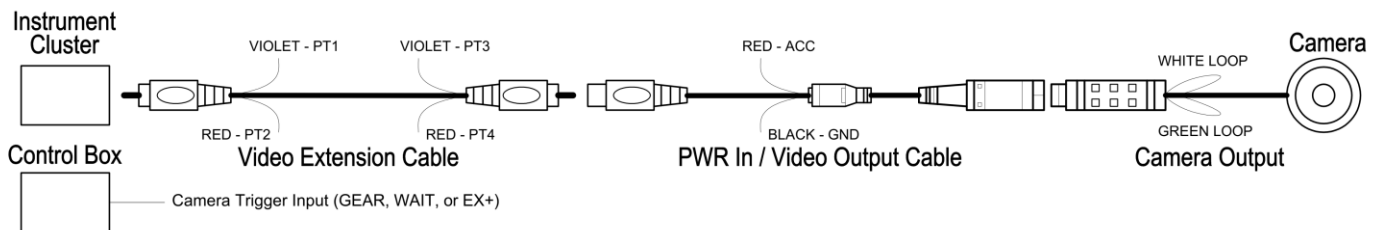

### Example #1: Backup light camera power and trigger

Connect the red 'ACC' wire to the backup lights at the rear of the vehicle. Connect the violet 'PT3' wire to that same point. At the control box, connect the violet 'PT1' wire in to either WAIT or EX+. Setup the GRAFIX as described above.

### Example #2: Backup light camera power and GSS GEAR trigger

Connect the red 'ACC' wire to the backup lights at the rear of the vehicle. At the control box, no additional trigger connection is required as the GSS will signal to the GRAFIX when the shifter in the 'reverse' position. Setup the GRAFIX as described above to use 'GEAR-REVERSE' as the camera trigger.

**Note: For all wiring applications, plug the 'Video Extension Cable' in to the rear of the GRAFIX Instrument Cluster. Also be sure to connect the black GND wire of the 'PWR In/Video Output Cable' to the vehicle GND. This can be accomplished by attaching the 'C' terminal on the black wire to a chassis bolt or screw.**

**Note: It is recommended that the power to the CAM-1000 is not hardwired to a constant +12V. Power should only be applied to the CAM-1000 when the vehicle is in reverse.**

**Note: If the backup assist lines are not desired on the backup video, tie the two green wires found on the Camera Output cable together. Be sure to properly seal the wire with tape or heat-shrink.**

## Camera Mounting

### Position and Cable routing

The CAM-1000 can be mounted several ways on the vehicle. Here are just a few examples:

**Note: The CAM-1000 does not have user adjustments for left/right alignment, so locating the camera as close as possible in the center of the vehicle will provide the best result**

- Face surface of the trunk lid or rear of the vehicle (image 1): Use the provided adhesive tape on the CAM-1000 bracket.
- Bottom side of the trunk lid (image 2): Use the adhesive tape, and if a more secure attachment is required, drill small holes and secure with sheet metal screws (screws not included).
- Above the license plate (using the optional CAM-LPB license plate mounting bracket)

**Note: When mounting the CAM-1000, make sure that the arrow on the camera is facing up. This will guarantee the image on the GRAFIX display will be orientated correctly.**

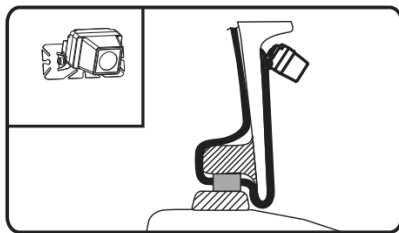

Image(1)

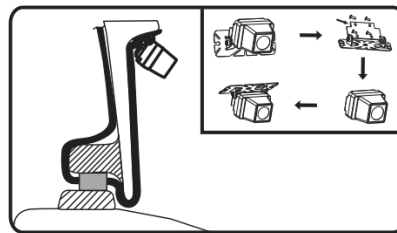

Image(2)

- Once camera is mounted, if possible route the Camera Assembly cable through a grommet along with an existing wire harness. If there is not a harness/hole available, route the cable through the weather strip or drill a hole in the desired location.
- Connect the 'Camera Assembly' cable to the 'PWR In/Video Output Cable', and then also connect the 'PWR In/Video Output Cable' to the 'Video Extension Cable'
- Route the 'Video Extension Cable' to the front of the vehicle, and connect the yellow RCA connector to the rear of the GRAFIX Instrument Cluster.

**Note: If drilling in the vehicle panel(s) to route cables, be sure to clean up any burrs on the surface and use a grommet (not included) in the hole and/or tape the wires properly so no future damage occurs.**

### Initial Alignment

With the CAM-1000 securely mounted in place, adjust the camera by moving as shown in Images 3 and 4 below. At this time adjust so the lens faces outward. The final adjustments will come once the wiring is completed and the video image is on the GRAFIX Instrument Cluster display.

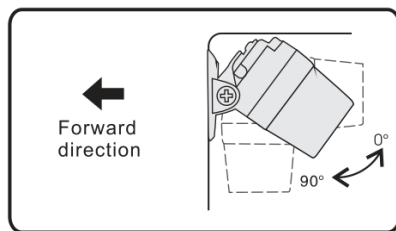

Image(3)

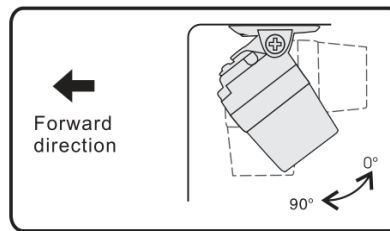

Image(4)

At this time the CAM-1000 is mounted, cables and connections are in place, and the Control Box should be configured for the selected trigger.

With the park brake on, turn on the ignition (do not start engine), and place the vehicle in reverse. The GRAFIX should now display the video from the CAM-1000 camera. If no video is present or video does not look correct, refer to the Troubleshooting Guide below.

## Final Adjustments

With the GRAFIX and CAM-1000 operational, it is time to make the final adjustments. One of the simplest ways to check for backup camera alignment is to find a parking lot with drive through front to back parking spaces.

- Pull through the parking spaces so that the back bumper of the vehicle is just ahead of the cross stripe between the two parking spaces
- Turn off the vehicle, engage the park brake, turn on the key (not engine) and place transmission in reverse
- Observe the video on the GRAFIX
- Adjust the CAM-1000 up and down so that the parking lot's 'cross' strip is visible on the bottom of the GRAFIX display. If needed - 'tweak' the CAM-1000 left and/or right so that the side stripes appear equal on the GRAFIX display, and are symmetric with the assist lines (if present)
- Tighten the CAM-1000 alignment screw with the provided hex wrench

**Note: Be sure to remove the protective film from the camera lens**

## Troubleshooting guide

Problem	Possible cause	Solution
GRFX Display Panel does not display camera video or have a blue raster	GRAFIX camera trigger not configured Reverse detection sensor is not functioning or is wired incorrectly Vehicle is not in reverse	Go in to the GRAFIX SETUP menu and set the proper trigger according to the wiring Confirm wiring is correct and trigger is present Make sure vehicle is in reverse
When in reverse, blue raster on GRAFIX, but no camera video	Camera is not powered on  Video not getting to the Instrument Cluster	Check that camera is getting power when vehicle is in reverse Check that all the yellow RCA connections are secure
Video image is not clear and/or appears noisy	Contaminants on camera lens Faulty video connection Noise getting on power or video wires  Bad or noisy GND connection	Clean lens with a soft cloth Check all connections and wiring Try different power source to the camera or rerouting the cables from camera to the GRAFIX Check GND connection of PWR In/Video Output Cable. May need to relocate GND Closer to the GRAFIX Instrument Cluster
Video looks foggy/fuzzy	Protective film still on lens	Be sure to remove the protective film from the lens

## Specifications

Sensor	CMOS
Resolution	648 x 488
TV Line	480
Min Illumination	0.3 Lux
Angle	170
Voltage	9-16V
Max Current	100mA
Video System	NTSC
Image	Mirror (Default)
Parking Lines	ON (Default)
Water Proof	IP67, IP68
Operating Temp	-30C - +70C
Storage	-40C - +105C

This page intentionally left blank.

## **SERVICE AND REPAIR**

DAKOTA DIGITAL offers complete service and repair of its product line. In addition, technical support is available to help you work through any questions or problems you may be having installing one of our products. Please read through the Troubleshooting Guide. There, you will find the solution to most problems.

For additional support, please visit [www.dakotadigital.com](http://www.dakotadigital.com). A “Product Support” link will be found at the bottom of the home page.

**Should you ever need to send the unit back for repairs, please call our technical support line, (605) 332-6513, to request a Return Merchandise Authorization number.**

- Package the product in a good quality box along with plenty of packing material.
- Ship the product by a common carrier with tracking abilities.
- Be sure to include the RMA number on the package.
- Include a complete description of the problem, with RMA number, your full name and address (street address preferred), and a telephone number where you can be reached during the day.
- Any returns for warranty work must include a copy of the dated sales receipt from your place of purchase.
- Send no money. We will contact you for payment.

### **Dakota Digital Limited Lifetime Warranty**

DAKOTA DIGITAL warrants to the ORIGINAL PURCHASER of this product that should it, under normal use and condition, be proven defective in material or workmanship for the lifetime of the original vehicle it was installed in, such defect(s) will be repaired or replaced at Dakota Digital’s option.

This warranty does not cover nor extend to damage to the vehicle’s systems, and does not cover diagnosis, removal or reinstallation of the product.

This Warranty does not apply to any product or part thereof which in the opinion of the Company has been damaged through alteration, improper installation, mishandling, misuse, neglect, or accident.

Dakota Digital assumes no responsibility for loss of time, vehicle use, owner inconvenience nor related expenses.

Dakota Digital will cover the return standard freight once the product has been evaluated for warranty consideration, however the incoming transportation is to be covered by the owner.

This Warranty is in lieu of all other expressed warranties or liabilities. Any implied warranties, including any implied warranty of merchantability, shall be limited to the duration of this written warranty. No person or representative is authorized to assume, for Dakota Digital, any liability other than expressed herein in connection with the sale of this product.

**⚠WARNING:** This product can expose you to chemicals including lead, which is known to the State of California to cause cancer and birth defects or other reproductive harm. For more information go to [www.P65Warnings.ca.gov](http://www.P65Warnings.ca.gov)



**4510 W. 61st St. North**  
**Sioux Falls, SD 57107**  
[www.dakotadigital.com](http://www.dakotadigital.com)  
[dakotasupport@dakotadigital.com](mailto:dakotasupport@dakotadigital.com)

Phone (605) 332-6513  
Fax (605) 339-4106

© Copyright 2023 - Dakota Digital