



## OEM Tank Hanger Instructions 12-305 – 1964-1970 Mustang

**Tools Needed:** Philips Head Screwdriver & In-Lb Torque Wrench

1. Select the desired vehicle configuration from the list below and use the following instructions with the corresponding year range.

1964-1968 (16 gallon tank)	Float arm A is mounted on the hanger assembly. Ready to install for 64-68 Mustang applications (skip steps 3-8)
1969 (20 gallon tank)	Utilize float arm 12-305B during step 5
1970 (22 gallon tank)	Utilize float arm 12-305C during step 5

2. Remove the two screws holding the fuel level sender onto the assembly (**Figure 1**).

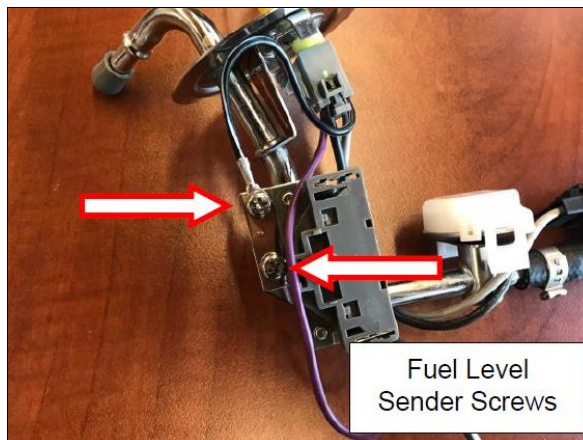

**Figure 1**

3. Align the float arm with the slot in the resistor cover plate (**Figure 2**).
4. Pull straight up on the float arm to remove the arm from the resistor assembly (**Figure 3**).  
**No tools are required for this operation and none should be utilized.**

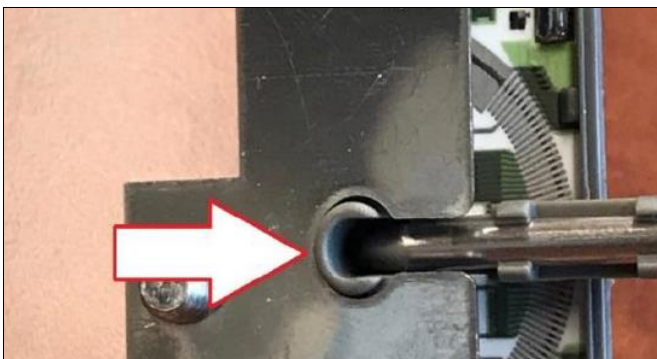

**Figure 2**



**Figure 3**

5. Select the proper float arm for your vehicle application from the list shown in step 1.
6. Place the wire end of the float arm through the hole in the center of the resistor assembly.
7. Ensuring the float arm and float arm receiver are aligned with the slot in the resistor cover plate (**Figure 4**), press the float arm straight down until fully seated into resistor assembly (**Figure 5**).

***No tools are required for this operation and none should be utilized.***

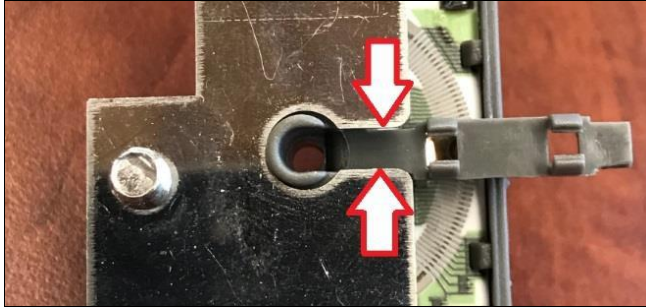

**Figure 4**

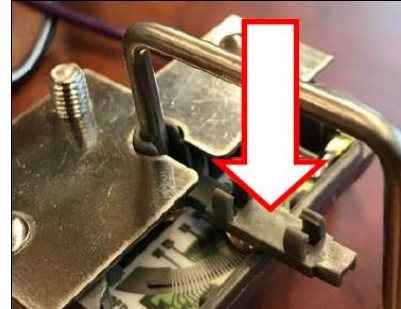

**Figure 5**

***Float arm must rotate freely after replacement (Figure 6).***



**Figure 6**

8. Install Supplied HydraMat onto the pump using the alignment dowel to locate (**Figure 7**). Press firmly to seat.



**Figure 7**

9. Insert the HydraMat and Pump assembly into the tank leaving the fuel level sender exposed (**Figure 8**). Be sure to insert the long end of the HydraMat into the tank first (**Figures 9-11**). When you get to the two screw holes for the level sender, insert the sender into the tank starting with the float and secure with mounting screws (**Figure 12**). Torque to  $23 \pm 3$  in-lbs.

**NOTE:** Be sure not to tear the HydraMat as it is being inserted into the tank.

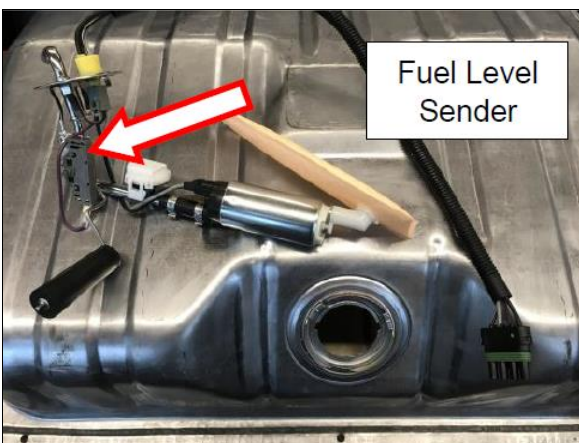

Figure 8



Figure 9



Figure 10

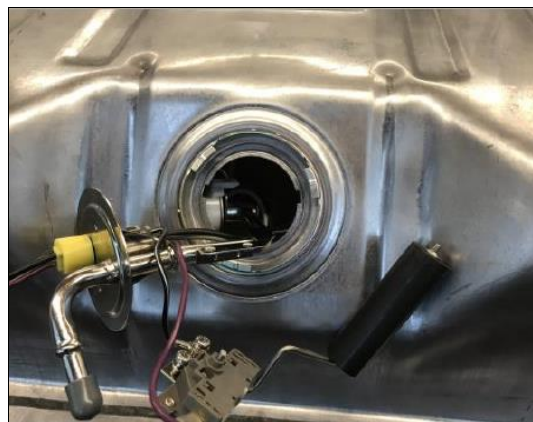

Figure 11



Figure 12

10. Run the supplied O-ring gasket over the supply tube and wires and stretch around the bulkhead plate (**Figure 13**).



**Figure 13**

11. Seat bulkhead plate on gasket and secure with locking ring (**Figure 14**).



**Figure 14**

## WIRING:

**WARNING! USE A MINIMUM OF 12 GAUGE WIRE. BE SURE TO CRIMP OR SOLDER ALL CONNECTORS SECURELY AND CLEAN ANY AREA WHERE GROUND LEADS WILL BE FASTENED. FAILURE TO USE THE MINIMUM WIRE GAUGE COULD RESULT IN PUMP MALFUNCTION AND/OR ELECTRICAL FIRE, RESULTING IN PROPERTY DAMAGE, SERIOUS INJURY, AND/OR DEATH.**

1. Disconnect the cables from the battery.
2. Mount relay/relays in convenient location away from exhaust heat.
3. Plug the fuel pump relay harness into the relay, until it locks into place.
4. Connect the black wire of the harness to ground.

**NOTE: Be sure to route all electrical wires clear of any moving suspension or drivetrain components and any exhaust components! Protect wires from abrasion and road obstructions or debris.**

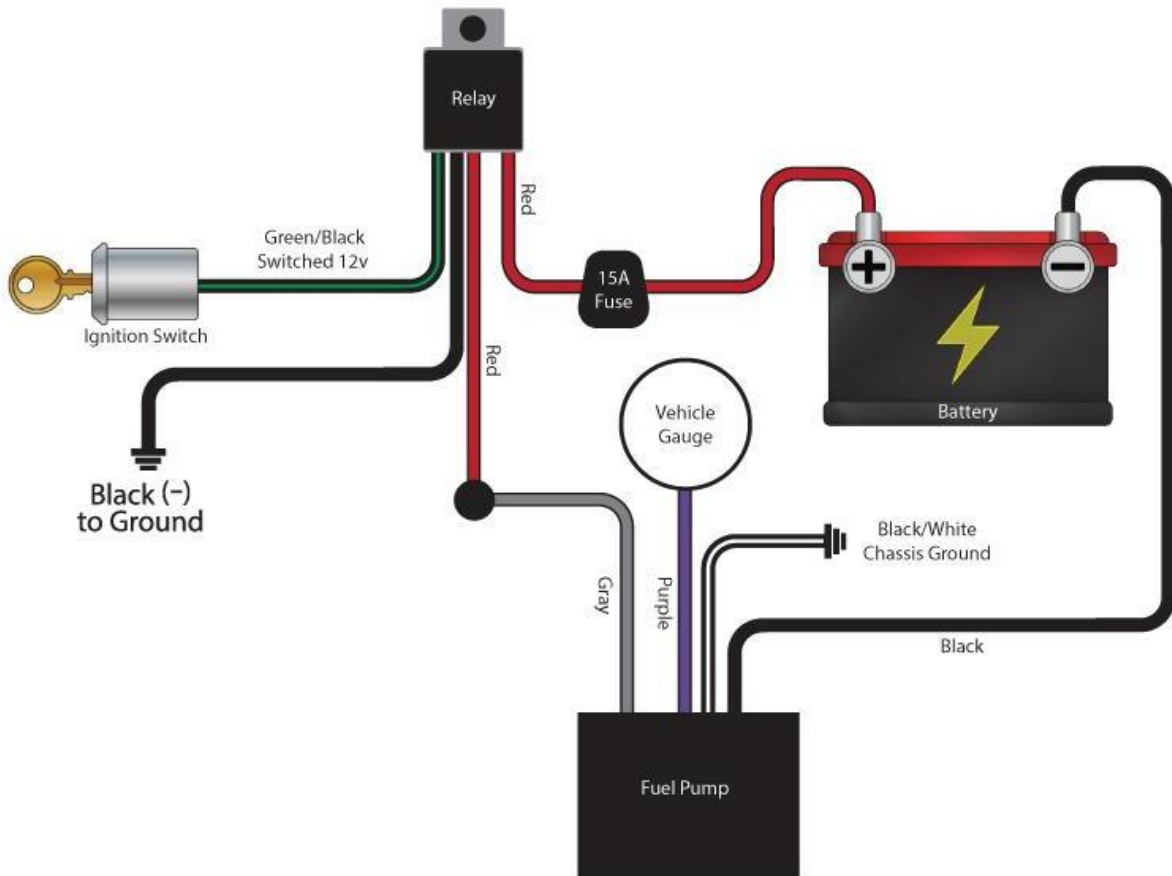

## Plumbing Note:

If connecting to factory vehicle fuel hard lines, make sure that any rubber hose and clamps used are rated for EFI Pressures.

**Technical Support: 1-866-464-6553**

**199R11695  
Date: 11-12-18  
77206959**